



Quadrifoglio Group

X9

design office

www.quadrifoglio.com



TOPS FOR DESKS AND RETURN UNITS

Made of 18mm veneered MDF board, matt transparent semi-open pore varnished 0.6mm wood veneer, 1mm wood veneer edging, front and back of top are 90° folded to form 50mm high side edges whose grain, being part of the same board, lines up perfectly with the top.
 Panel density 720/790 kgs per cubic meter.

Finish options:

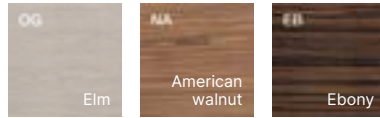

TOPS FOR DESKS WITH LEATHER INLAY

Leather insert made from 18mm melamine faced particle board (MFC) with 50mm high 90° folded front edge. Top and edge outer surface covered with 1.3mm abrasion resistant leather finished with matching decorative stitching along the perimeter of the panel. Panel density 670/730 kgs per cubic meter.

Finish options:

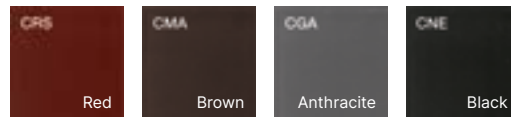

Production lead time: 5 weeks excluding delivery time.

METAL FRAME



Epoxy powder coated steel frame.

Finish options:

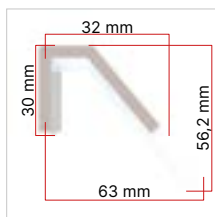
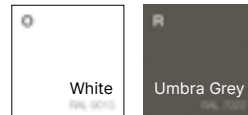

Tapered legs made of 4mm steel open sections, cross section tapers from 30×32mm (lower end) to 63×56.2mm (upper end)

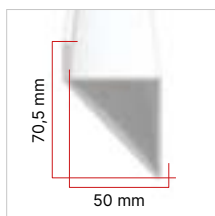

Crossbar between legs made of 50×70.5mm 2mm steel hollow tube, beams are fitted using steel brackets welded to crossbar.

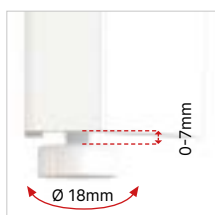

0-7mm adjustable levelling feet made of grey polyethylene, 18mm diameter.

MODESTY PANEL (OPTIONAL EXTRA)

Made of 18mm veneered particle board, matt transparent semi-open pore varnished 0.6mm wood veneer, 1mm thick wood veneer edges, 0.5 mm radius corners. Panel density 720/790 kgs per cubic meter. 3mm epoxy powder coated steel mounting brackets.

Finish options:

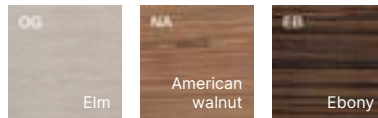

VENEERED COMBINATION UNIT

Made of 18mm veneered particle board. Matt transparent semi-open pore varnished 0.6mm wood veneer, 1mm thick wood veneer edges, 0.5 mm radius corners.

Spacious compartment for power/data blocks and cables, access through a soft close epoxy powder coated extruded aluminium flap complete with brush strip. Lower open shelf to place objects such as handbags, binders or a CPU.

Back made of 18mm veneered particle board. Matt transparent semi-open pore varnished 0.6mm wood veneer, 1mm thick wood veneer edges, 0.5 mm radius corners.

3 drawer + 1 pen drawer static pedestal including epoxy powder coated metal drawers in silver, central locking with two folding keys, full extension metal slides with safety stop mechanism, anti-slam soft close. 80% extension pen drawer.

Finish options:

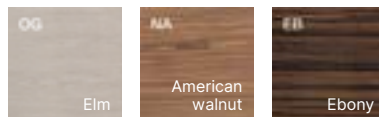

LAQUERED COMBINATION UNIT

Made of 18mm melamine faced particle board (MFC) finished with 1mm ABS anti-impact edges.

Spacious compartment for power/data blocks and cables, access through a soft close epoxy powder coated extruded aluminium flap complete with brush strip.

Lower open shelf to place objects such as handbags, binders or a CPU.

3 drawer + 1 pen drawer static pedestal including epoxy powder coated metal drawers in silver, central locking with two folding keys, full extension metal slides with safety stop mechanism, anti-slam soft close. 80% extension pen drawer.

Cabinet and pedestal are supplied coated in scratch/abrasion resistant matt lacquer.

Finish options:



METAL BACK

The cabinets available in the L-shaped desks can be also supplied with a perforated metal back made of scratch/fingerprint resistant epoxy powder coated 1.5mm steel. Available in a matching finish to the desk frame.

CABLE FLAPS

Flaps are made of epoxy powder coated 6060 extruded anodized aluminium.

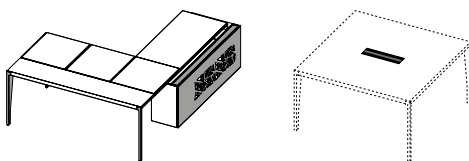

Finish options:

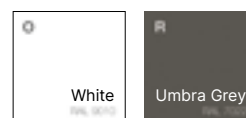

MOBILE PEDESTALS

3-drawer + 1-pen drawer mobile pedestal made of 18mm veneered particle board. Matt transparent semi-open pore varnished 0.6mm wood veneer, 1mm thick wood veneer edges, 0.5 mm radius corners. Epoxy powder coated metal drawers in silver, central locking with two folding keys, full extension metal slides with safety stop mechanism, anti-slam soft close. 80% extension pen drawer. Four embedded black nylon 360° swivel castors, ø52mm.

Metal handles
Zen



White (A)
Umbra Grey (Q)

Finish options:

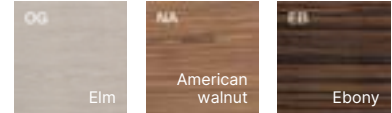

DESK

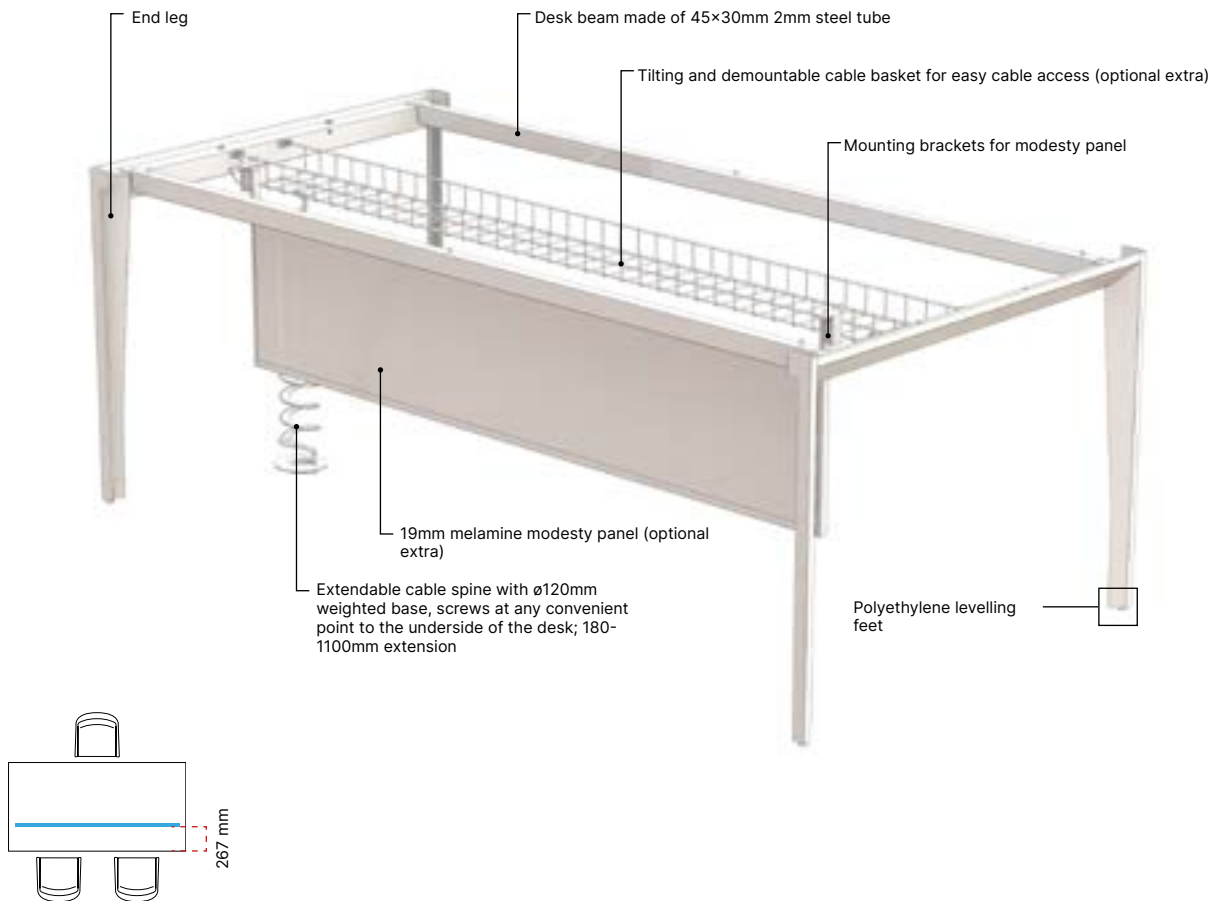

L-SHAPED DESK WITH COMBINATION UNIT

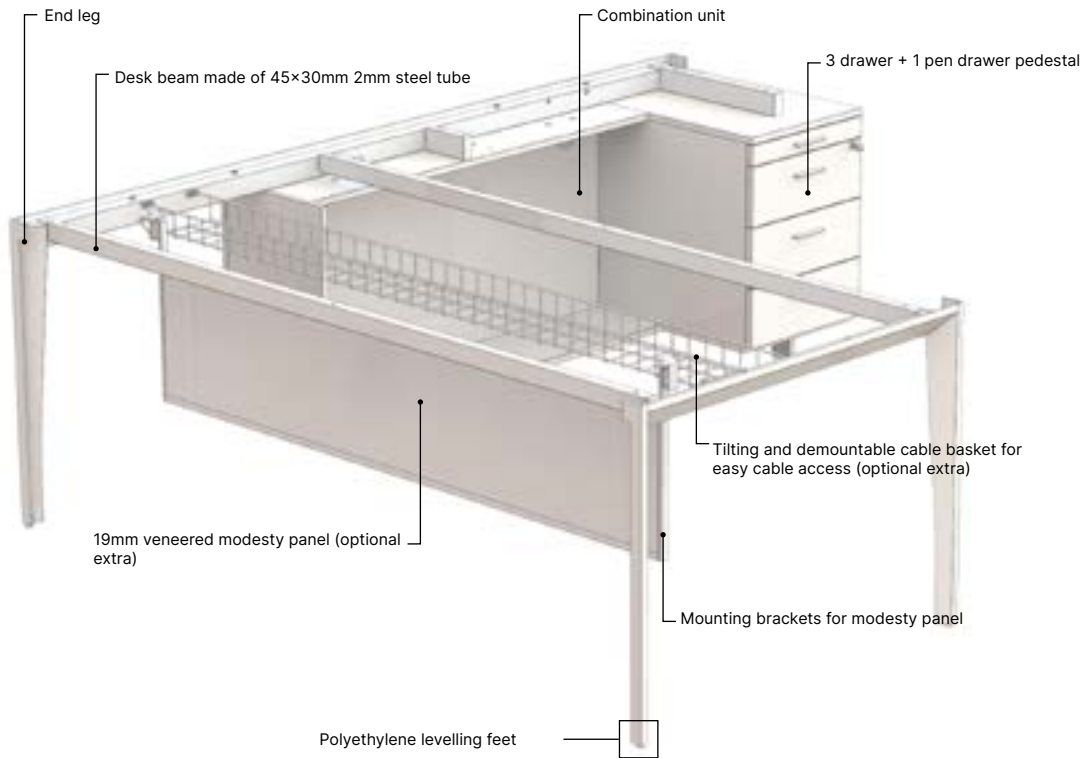

TOPS FOR TABLES AND COFFEE TABLES

Made of 18mm veneered MDF board, matt transparent semi-open pore varnished 0.6mm wood veneer, 1mm wood veneer edging, front and back of top are 90° folded to form 50mm high side edges whose grain, being part of the same board, lines up perfectly with the top.
 Panel density 720/790 kgs per cubic meter.

Finish options:

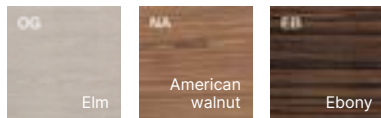

TOPS FOR TABLES WITH LEATHER INLAY

Leather insert made from 18mm melamine faced particle board (MFC) with 50mm high 90° folded front edge. Top and edge outer surface covered with 1.3mm abrasion resistant leather finished with matching decorative stitching along the perimeter of the panel. Panel density 670/730 kgs per cubic meter.

Finish options:

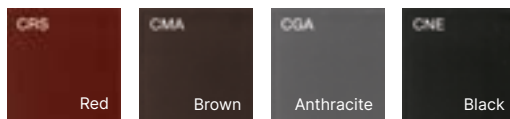

Production lead time: 5 weeks excluding delivery time.

TABLE FRAME



Epoxy powder coated steel frame.

Finish options:

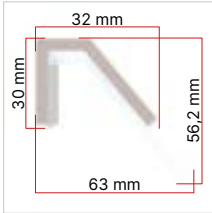
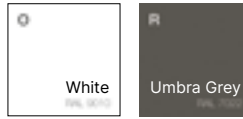

Tapered legs made of 4mm steel open sections, cross section tapers from 30x32mm (lower end) to 63x56.2mm (upper end)

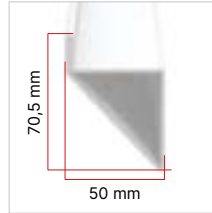

Crossbar between legs made of 50x70.5mm 2mm steel hollow tube, beams are fitted using steel brackets welded to crossbar.

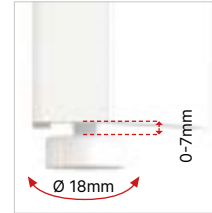

0-7mm adjustable levelling feet made of grey polyethylene, 18mm diameter.

COFFEE TABLE FRAME



Loop legs made of 50x6mm epoxy powder coated steel flat bar welded to two 3mm thick steel mounting plates. Supplied with antislip felt pads.

Finish options:

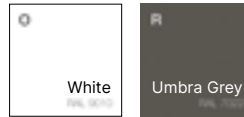

SINGLE SECTION TABLE

Cable tray with flap opening from either side



TWO-SECTION TABLE

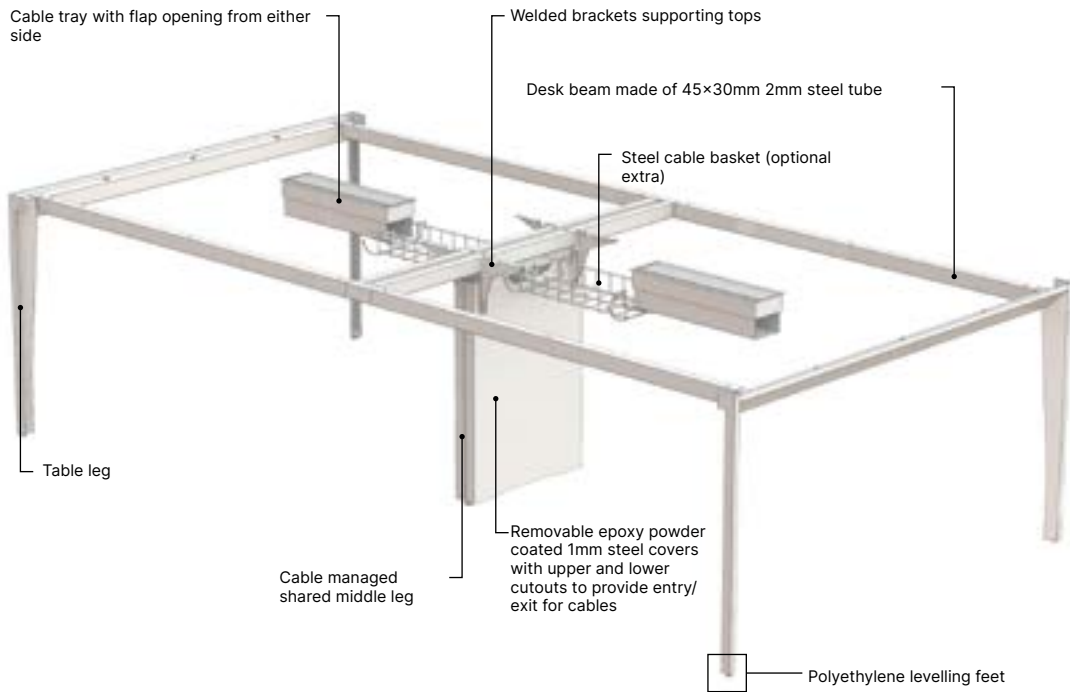

Detail: cable managed shared middle leg

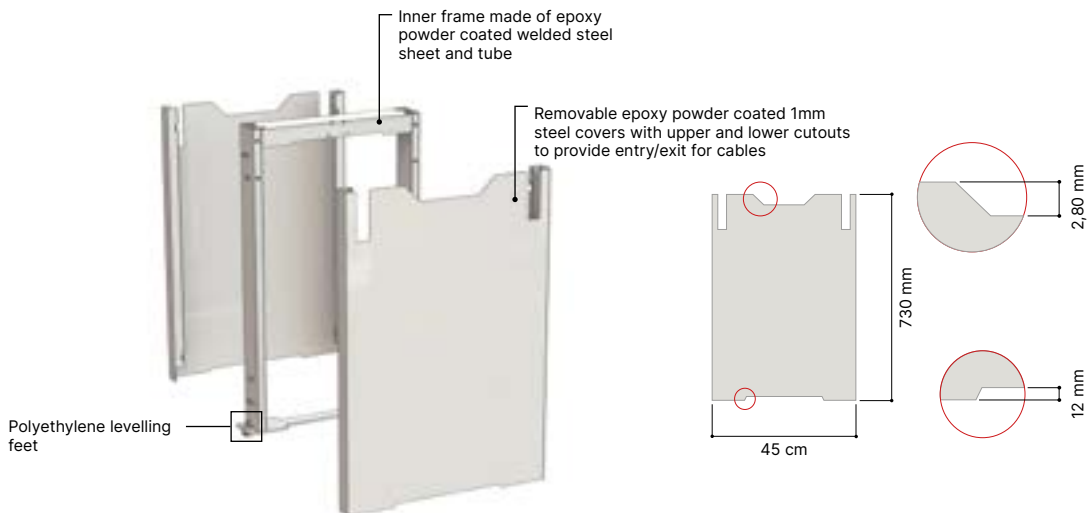

DESKS & L-SHAPED DESKS

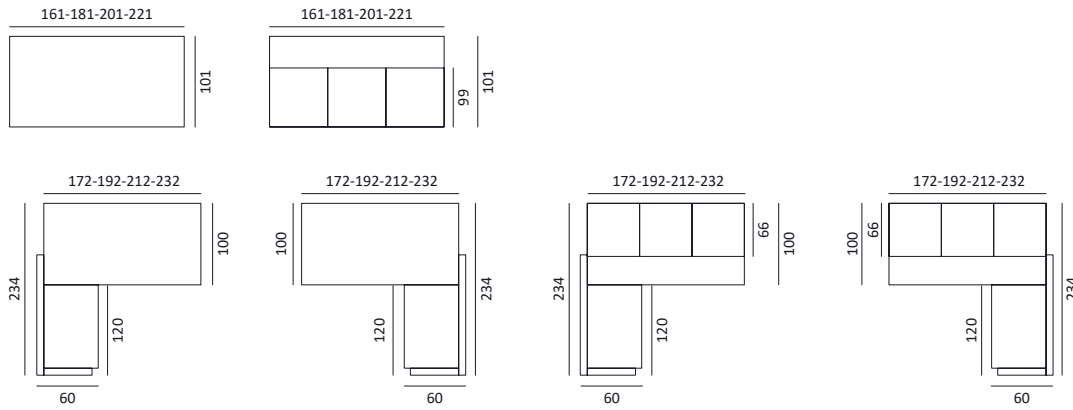

MEETING & BOARDROOM TABLES



COFFEE TABLES

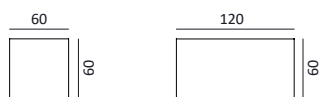

PEDESTALS

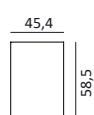

DESK

DESK WITH LEATHER INLAY

- 1) 19mm veneered top
- 2) 20mm leather covered MFC inlay
- 3) Beam
- 4) Cable basket (optional extra)
- 5) Leg
- 6) Veneered modesty panel (optional extra)

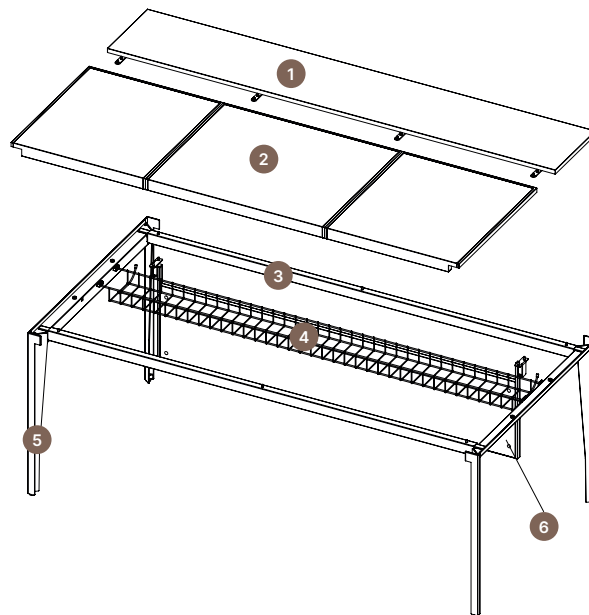

L-SHAPED DESK WITH LEATHER INLAY

- 1) 19mm veneered desk top
- 2) 19mm veneered return top
- 3) Cable basket (optional extra)
- 4) Leg
- 5) Beam
- 6) Leg for L-shaped desks
- 7) Cabinet
- 8) 3-drawer + 1-pen drawer pedestal
- 9) Cable flap
- 10) ø60mm inner grommet
- 11) Veneered or lacquered back panel
- 12) Perforated metal back panel

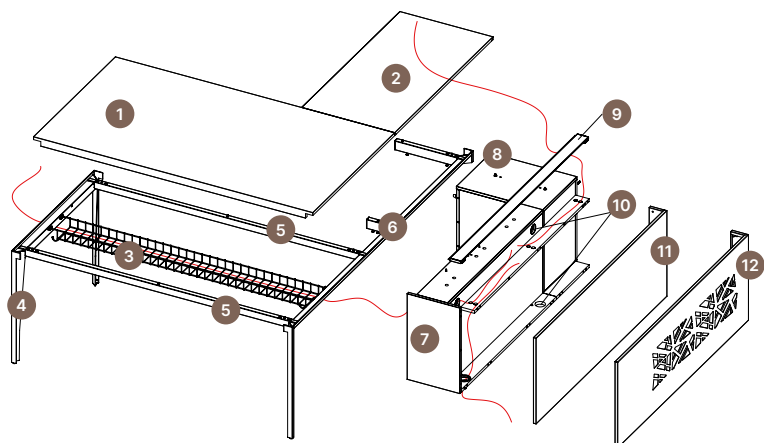

MEETING/BOARDROOM TABLE

- 1) 19mm veneered table top
- 2) Cable flap
- 3) Cable tray
- 4) Cable basket (optional extra)
- 5) Beam
- 6) Cable managed shared middle leg

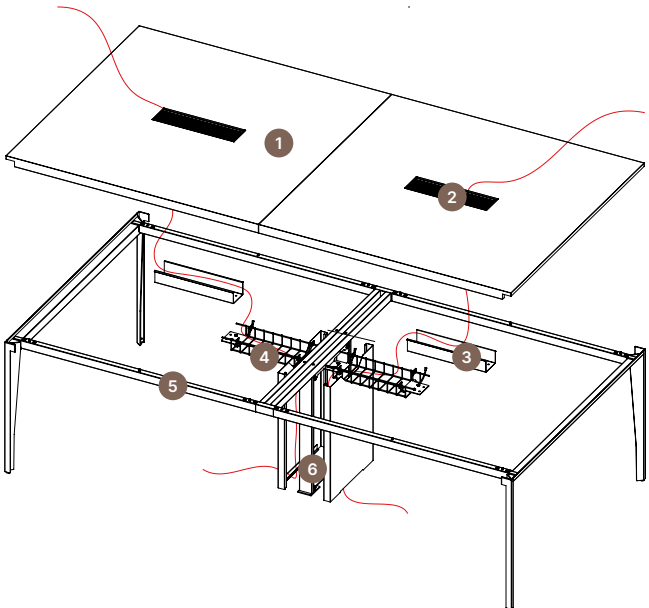



Extendable cable spine



Cable basket for desks



Cable basket for two-section or longer tables



3 drawer + pen drawer mobile pedestal



Veneered modesty panel



MATERIALS AND RECYCLABILITY

MFC panels used for X9 range tables are solely manufactured with 100% recycled wood and fully meet requisites of formaldehyde low emissions (CARB Quality Award CATAS Certificate). Resins used for panels and melamines are free of SVHC substances (to be found in the ECHA list updated as of 12/01/2017).



STANDARDS

X9 range has passed the following tests, attested by  analysis laboratory in San Giovanni al Natisone (UD).

- Office work tables: safety requirements EN 527-2:2016+A1:2019 clause 4.1 - 4.2
- Office work tables: information for use EN 527-2:2016+A1:2019, clause 6
- Tables and desks dimensions EN 527-1:2011
- Horizontal static load test EN 1730:2012, clause 6.2
- Vertical static load test EN 1730:2012, clause 6.3
- Horizontal fatigue test EN 1730:2012, clause 6.4.2
- Stiffness of the structure EN 1730:2012, clause 6.4.3
- Vertical fatigue test EN 1730:2012, clause 6.5
- Vertical impact test EN 1730:2012, clause 6.6
- Drop test EN 1730:2012, clause 6.9
- Stability under vertical load EN 1730:2012, clause 7.2
- Deflection of table tops EN 1730:2012, clause 6.7



CERTIFICATES

Constantly receptive to market requirements, Quadrifoglio Sistemi d'Arredo pay special attention on quality and safety contents in order to provide high products and services. The Company has reached certifications UNI EN ISO 9001/2015, UNI EN ISO 14001/2015 and UNI EN ISO 45001/2018 to confirm his policy. Our products are certified and ensured by FSC™ and ECOLOGICAL PANEL.



GREEN ENERGY

The Company had installed the photovoltaic system with 4.500 solar panels in a 7.350 m² surface that covers almost entirely the factory. The photovoltaic is able to produce 1Mw of a quiet green energy, that does not harm the environment and is waste-free. With his high production capacity the photovoltaic allows us to reduce emissions in the atmosphere of all those polluting substances and to those that contribute to the greenhouse effects. Consequently, such measures make us save every year 180 tonne of petrol oil, 440 tonne of CO₂, 514kg of sulphur dioxide, 448 kg of nitrogen oxide and 23kg of dust.



TRANSPORT

Detachable systems. Volumes that facilitate the optimization of space. Maximum reduction of energy consumption by transport.



CERTIFICATES

Constantly receptive to market requirements, Quadrifoglio Sistemi d'Arredo pay special attention on quality and safety contents in order to provide high products and services. The Company has reached certifications UNI EN ISO 9001/2015, UNI EN ISO 14001/2015 and UNI EN ISO 45001/2018 to confirm his policy. Our products are certified and ensured by FSC™ and ECOLOGICAL PANEL.



GREEN ENERGY

The Company had installed the photovoltaic system with 4.500 solar panels in a 7.350 m² surface that covers almost entirely the factory. The photovoltaic is able to produce 1Mw of a quiet green energy, that does not harm the environment and is waste-free. With his high production capacity the photovoltaic allows us to reduce emissions in the atmosphere of all those polluting substances and to those that contribute to the greenhouse effects. Consequently, such measures make us save every year 180 tonne of petrol oil, 440 tonne of CO₂, 514kg of sulphur dioxide, 448 kg of nitrogen oxide and 23kg of dust.



TRANSPORT

Packaging is reduced in order to decrease volumes. Goods collections are responsibly managed and organised with the aim of optimise transports, reducing atmosphere emissions.