

CLUSTER 3-PERSON UPHOLSTERED BENCH

COD.OCLUS301



DESCRIPTION

3-person bench with upholstered seat and backrest

NOTE

Accessories: Armrest; Table for seat substitution; Fixed legs.

11M fire retardant B01 fabric upholstered shell 

UNI EN 1022, 1728, 15373, 13761 

SPECIFICATIONS

STRUCTURE

Aluminum finished steel frame 1,2mm; Upholstered seat and backrest with internal wooden panel

PADDING

Seat: thickness 20 mm, density 40 Kg/m³

Backrest: thickness 15 mm, density 30 Kg/m³

ARMS

Aluminum finished steel

LEGS / FRAME / BASE

Steel tube legs 90x30x1,5 with aluminum finish

Steel tube beam 80x40x1,5 with aluminum finish

UPHOLSTERY

categories B01-B03-C01-C05-D02-P01 (SEE FABRIC FOLDER)

SIZE

bench
L 2030 H 860 D 670

seat
L 490 H 440 D 440

backrest
L 490 H 475

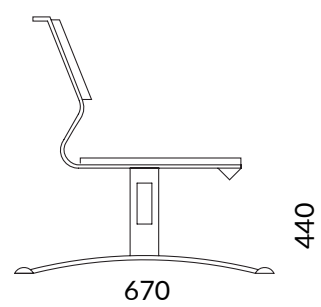
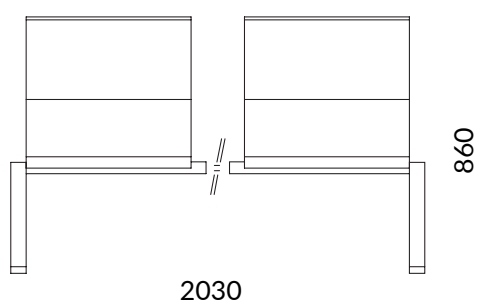

WEIGHT

Net weight: 45 Kg
Gross weight: 48 Kg

PACKAGING

2 packages

VOLUME

M3 box: 0,4

COD.OCLUS301

TECHNICAL
DATASHEET

Dimensions in millimeters